

# C23 Dusch Hörn / Shower Corner

## MONTERINGSANVISNING ASSEMBLY INSTRUCTION

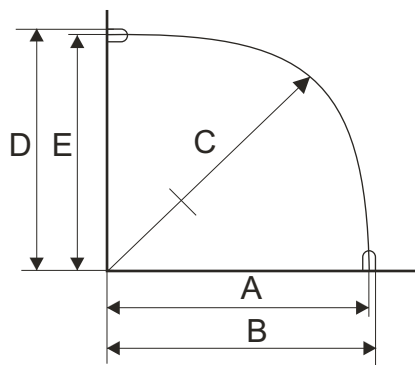

**C23-90**  
90x90x190cm

**C23-1080**  
100x80x190cm

**C23-80**  
80x80x190cm  
(mm)

A  
B  
C  
D  
E

855  
885  
R=510  
885  
855







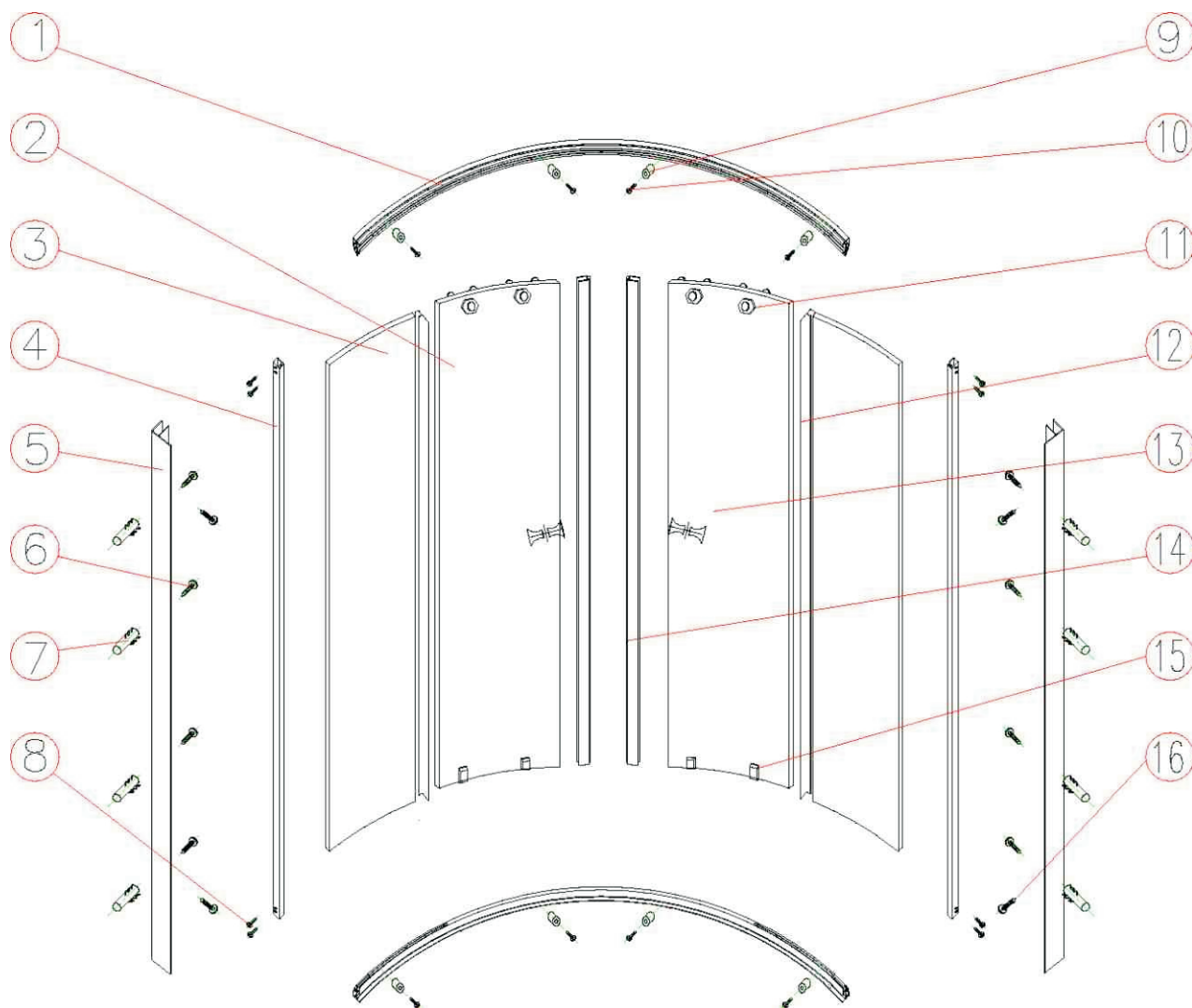



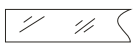

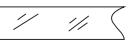

955  
985  
R=510  
785  
755

755  
785  
R=510  
785  
755

Total höjd / total height: 1900 mm



### Komponentlista / Component list

(1)	Topp och botten spårprofil Top & Bottom tracks	2		(9)	Dörrstopp Bumpers	8	
(2)	Skjutdörr, glas Sliding glass doors	2		(10)	Skruv för dörrstopp(3,5x10) Screws for bumpers	8	
(3)	Glaspanel Glaspanel	2		(11)	Hjul Rollers	4	
(4)	Sidoprofil Door Jamb	2		(12)	Plastlist Plastic strips	2	
(5)	Väggprofil Wall jamba	2		(13)	Handtag Handles	2	
(6)	Skruv (4x30) Screws	8		(14)	Magnetlist Magnetic strips	2	
(7)	Väggplugg Anchor	8		(15)	Glidskena Skates	4	
(8)	Skruv (4x30) Screw	8		(16)	Skruv (4x8) Screw	4	

## Förberedelse

- 1) Läs instruktionerna noggrant. Kontrollera alla delar för transportskador etc. Kontakta oss eller din lokala handlare om något saknas eller är skadat.
- 2) Verktyg som behövs:  
Skruvmejsel eller skruvdragare med spårhuvud och Phillips stjärnmejsel, skiftnyckel, vattenpass, linjal, blyertspenna, silikonpistol, bormaskin och 6 mm borr för väggplugg.

## Installation och justering

- A). Placera väggprofil (5) på plats och markera hålens position, borra hål och placera väggplugg(7) i hålen. Fixera väggprofilen mot väggen med skruv (6) vertikalt, kontrollera noga med vattenpass.
- B) Montera ihop topp- och bottenprofil(1), och sidoprofil(4) till en ram.
- C). Skjut in ramen i väggprofilen (5)
- D). Placera Glaspanel (3) i sidoprofilen.
- E). Montera hjul och skenor på skjutdörrarna och placera i topp och botten spårprofilerna. Installera dörrstopp(9).
- F). Montera Handtag (13) och plastlist(12).
- G). Justera höjden på hjulen till dess att skjutdörrarna glider jämnt och friktionsfritt, fäst skruvarna på hjulen.
- H). Justera duschhörnet och borra 2 hål i vardera väggprofil och sidoprofil. Fäst väggprofilen mot ramen med 4x8 skruv (16).
- I). Täta med silikon i alla skarvar runtom mellan duschram, golv och väggar.

## Preparation

- 1) Read the instruction carefully, check all the parts transportation damages.
- 2) Tools needed:  
Flathead, and Philips head screwdriver, level, pencil, 14-16mm adjustable wrench, silicone-gue gun. Power Drill and drill.

## Installation and adjustment

- A) Place wall jambs (5) in proper position, mark the screw hole positions on the wall, use level, and drill holes with power drill. Place the anchors (7) in drilled holes. Attach the wall jambs with screws (6) to the wall.
- B) Assemble the top and bottom tracks (1) to door jambs(4) with screws (4x30) (8), and make it into a frame.
- C) Insert the above frame into wall jambs (5) slightly, and adjust the frame to a suitable position.
- D) Insert glass panel (3) into door jambs (4) one by one.
- E) Install rollers (11) and skates (15) onto sliding glass doors (2), then slide the glass doors into top and bottom tracks (1) from the opening in the middle of the tracks. Install bumpers (9) onto suitable positions with screws (10).
- F). Install the handles (13) and plastic strips(12).
- G). Adjust the height of rollers (11) on the glass doors with a flat head screwdriver and a adjustable wrench until the doors run smoothly. Tighten the screws on the rollers.
- H) Adjust the shower enclosure frame and then drill holes on wall jambs (5) and door jambs (4) from inside. Attach wall jambs and door jambs together with screws(16).
- I) Caulk silicone-gue into the gaps between the shower enclosure and the wall and floor.